

# SMD SPX0 3.2x2.5mm 1.8 - 3.3 VDC MHz

## SERIES "SX0"

### FEATURES

- + Low power version / Stand-by current 10 µA max.
- + Frequency stability to ±20 ppm available
- + Available in 1.8, 2.5, 2.8, 3.0 and 3.3 VDC
- + New standard for small high performance low cost crystal oscillators
- + Low jitter for excellent performance



PB FREE / ROHS-2 2011/65/EU COMPLIANT

### GENERAL DATA

PARAMETERS		PRODUCT FEATURES AND CONDITIONS			
SMD-OSCILLATOR SERIES		SX0-03025			
PACKAGE		Ceramic package 3.2 x 2.5 x 1.2 mm <sup>3</sup>			
FREQUENCY RANGE		0.6 ~ 80.0 MHz	+1.8 VDC ±10%		
		0.2 ~ 157.0 MHz	+2.5 VDC ±10% / +2.8 VDC ±10%		
		0.2 ~ 167.0 MHz	+3.0 VDC ±10% / +3.3 VDC ±10%		
FREQUENCY STABILITY		0/+70°C ~ -10/+60°C	±20 ~ ±100 ppm		
		-20/+70°C	±25 ~ ±100 ppm		
		-40/+85°C ~ -40/+105°C	±50 ~ ±100 ppm		
		-40/+125°C	±100 ppm		
		The frequency stability contains the frequency tolerance at 25°C, the temperature stability, supply voltage change and load change. The aging is ±3ppm max. per year.			
OPERATING TEMPERATURE RANGE		-10/+60°C ~ -40/+125°C			
STORAGE TEMPERATURE RANGE		-55/+125°C			
INPUT	CURRENT	FREQUENCY	+1.8 VDC ±10%		
		0.2~32.0 MHz	1.0 mA max. (no load)		
		32.0~54.0 MHz	1.4 mA max. (no load)		
		54.0~80.0 MHz	3.0 mA max. (no load)		
		FREQUENCY	+2.5 VDC ±10%		+2.8 VDC ±10%
		0.2~32.0 MHz	1.5 mA max. (no load)		1.8 mA max. (no load)
		32.0~54.0 MHz	2.0 mA max. (no load)		2.5 mA max. (no load)
		54.0~125.0 MHz	4.0 mA max. (no load)		5.0 mA max. (no load)
		125.0~157.0 MHz	6.0 mA max. (no load)		7.0 mA max. (no load)
		FREQUENCY	+3.0 VDC ±10%		+3.3 VDC ±10%
		0.2~32.0 MHz	1.8 mA max. (no load)		1.8 mA max. (no load)
		32.0~54.0 MHz	2.5 mA max. (no load)		2.5 mA max. (no load)
		54.0~80.0 MHz	5.0 mA max. (no load)		5.0 mA max. (no load)
		80.0~125.0 MHz	6.0 mA max. (no load)		6.0 mA max. (no load)
125.0~167.0 MHz	8.0 mA max. (no load)		8.0 mA max. (no load)		

## GENERAL DATA (CONTINUED)

PARAMETERS		PRODUCT FEATURES AND CONDITIONS	
OUTPUT	SYMMETRY	STANDARD	40/60% at 50% VDD Level
		OPTION	45/55% at 50% VDD Level
	RISE AND FALL TIME		7 ns max. (L <sub>CMOS</sub> 15 pF = 10~90% VDD Level) for +1.8 VDC ±10%
			5 ns max. (L <sub>CMOS</sub> 15 pF = 10~90% VDD Level) for +2.5, 2.8, 3.0, 3.3 VDC ±10%
	"0" LEVEL	CMOS	10% VDD max.
"1" LEVEL	90% VDD min.		
	LOAD	CMOS	15 pF max.
PIN1		STANDARD	WITH ENABLE / DISABLE FUNCTION
ENABLE / DISABLE FUNCTION		PIN #1 (E/D CONTROL)	PIN #3 (OUTPUT)
		OPEN	ACTIVE
		HIGH "1" (V <sub>IH</sub> >80%VDC)	ACTIVE
		LOW "0" (V <sub>IL</sub> <20%VDC)	HIGH IMPEDANCE
		OUTPUT DISABLE TIME	150 ns max.
		OUTPUT ENABLE TIME	1 ms max.
		STAND-BY CURRENT 10 µA max.	
DELIVERY FORM		Tape and Reel / 2.000 pcs. per reel, other quantities are available on request	
<b>OTHER PARAMETERS ARE AVAILABLE ON REQUEST / CREATE HERE YOUR SPECIFICATION</b>			

## OUTLINE DRAWING

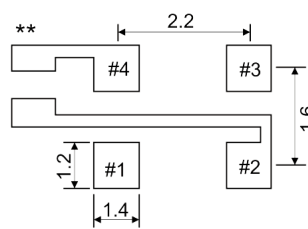
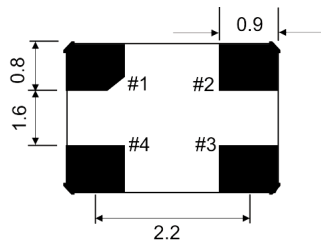
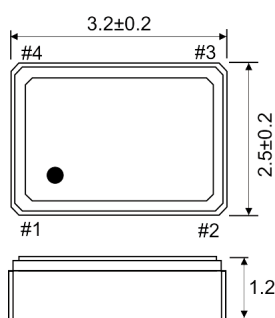

PIN	CONNECTION
#1	N.C. or ENABLE/DISABLE
#2	GROUND
#3	OUTPUT
#4	VDD

Unit:mm

\*\*A capacitor of value 0.01µF or greater between VDD and Ground is recommended

## REEL SPECIFICATION

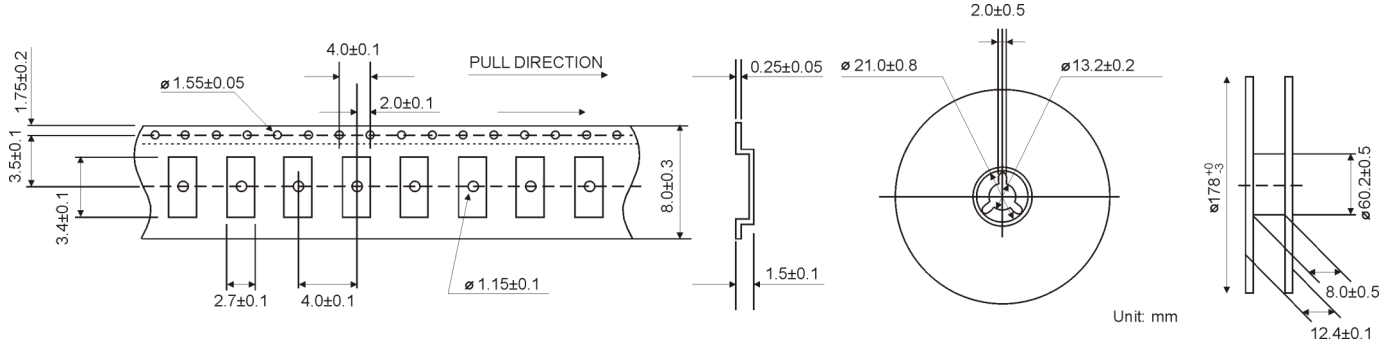

## TEST CIRCUIT CMOS

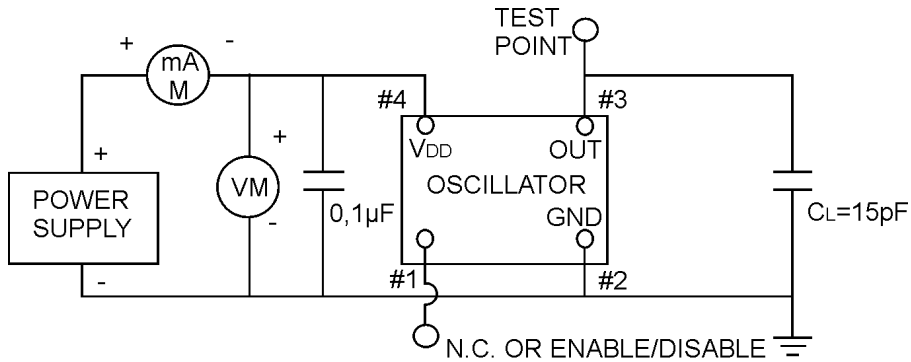

NOTE: CL includes probe and fixture capacitance

## REFLOW SOLDER PROFILE

## OUTPUT WAVE FORM CMOS

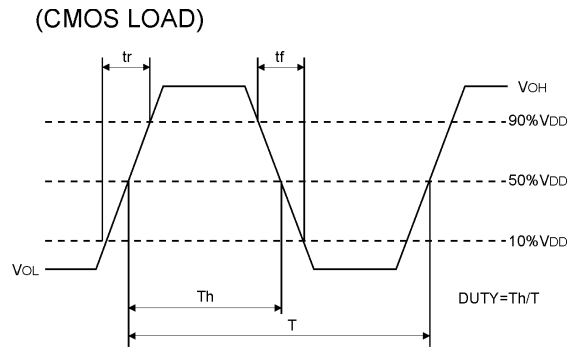
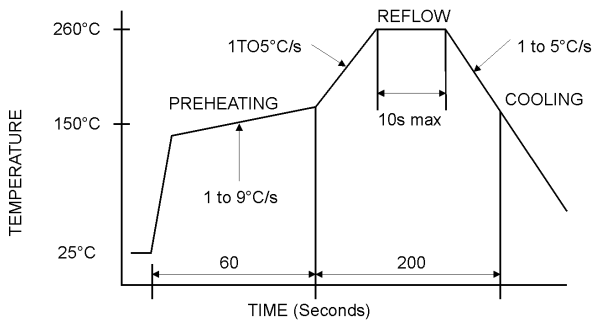

## ORDERING INFORMATION

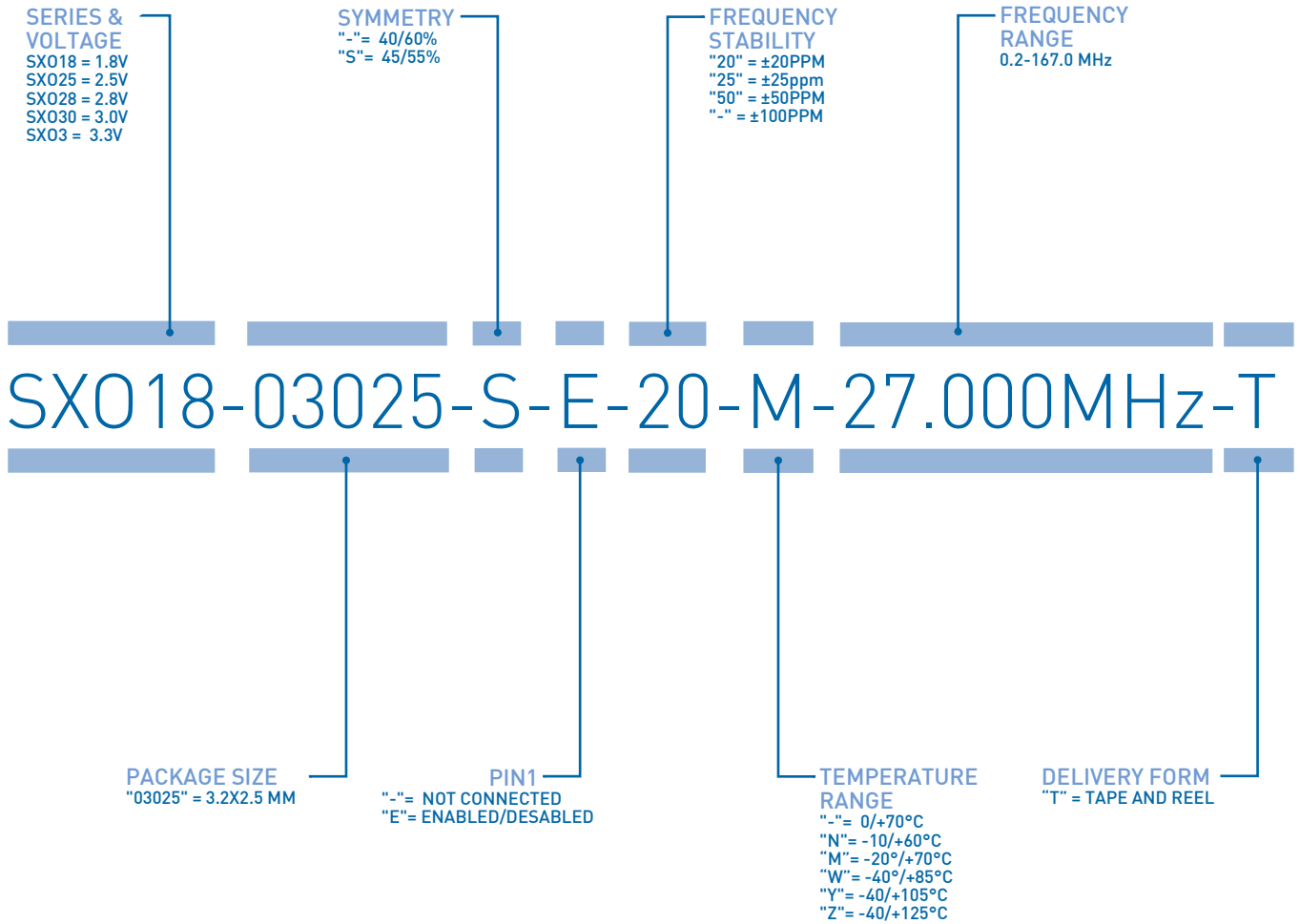

EXAMPLE: SX018-03025-S-E-20-M-27.000MHz-T  
 PLEASE INDICATE YOUR REQUIRED PARAMETERS



## PREMIUM QUALITY BY PETERMANN-TECHNIK



OUR COMPANY IS CERTIFIED ACCORDING TO ISO 9001:2015 IN OCTOBER 2016 BY THE DMSZ CERTIFIKATION GMBH.

THIS IS FOR YOU TO ENSURE THAT THE PRINCIPLES OF QUALITY MANAGEMENT ARE FULLY IMPLEMENTED IN OUR QUALITY MANAGEMENT SYSTEM AND QUALITY CONTROL METHODS ALSO DOMINATE OUR QUALITY STANDARDS.